

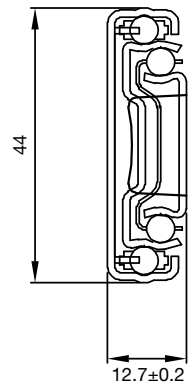

### Glisiera cu bile 04227

Varianta: extragere totala  
 Tip montaj: montaj lateral  
 Latime: 12,7 mm  
 Inaltime: 44 mm  
 Capacitate portanta: 45 kg  
 Material: otel zincat



Art. nr.	Lungime sina mm	Varianta extragere mm	UM	Pret RON	per
103 345 020	250	250	set	10,91	1 set
103 345 021	300	300	set	13,03	1 set
103 345 022	350	350	set	15,31	1 set
103 345 023	400	400	set	17,43	1 set
103 345 024	450	450	set	19,70	1 set
103 345 025	500	500	set	21,83	1 set
103 345 026	550	550	set	24,10	1 set
103 345 027	600	600	set	26,22	1 set
103 345 028	650	650	set	28,34	1 set
103 345 029	700	700	set	30,62	1 set

Grupa produs 300 332

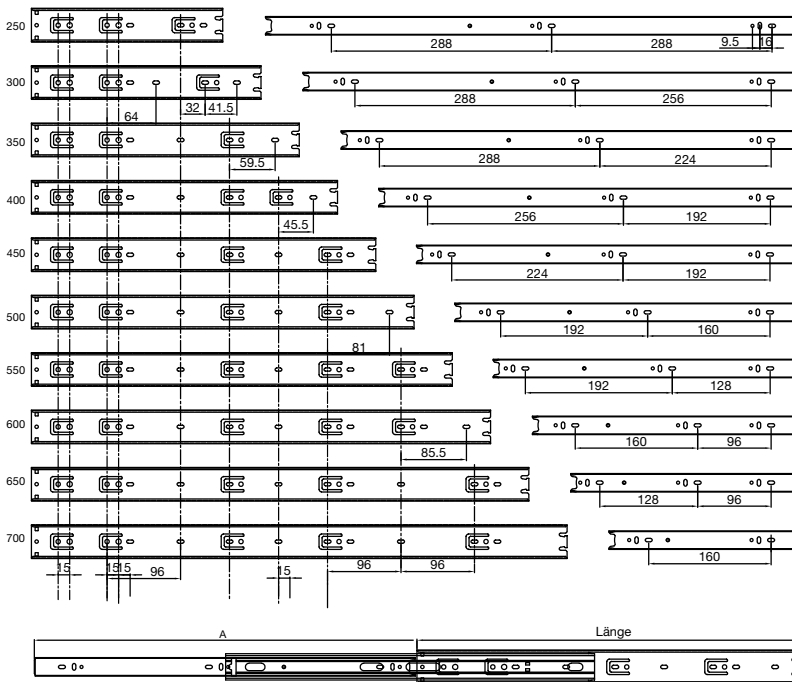

Länge	A
700	700
650	650
600	600
550	550
500	500
450	450
400	400
350	350
300	300
250	250



### Glisiera cu bile 04276 - Softclose

Varianta: extragere totala  
 Dotare: sistem de amortizare Soft-Close  
 Tip montaj: montaj lateral  
 Latime: 12,7 mm  
 Inaltime: 44,6 mm  
 Capacitate portanta: 40 kg  
 Material: otel zincat

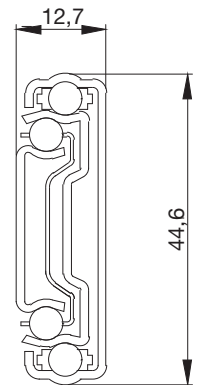

Art. nr.	Lungime sina mm	Varianta extragere mm	UM	Pret RON	per
103 345 030	250	200	set	17,73	1 set
103 345 031	300	240	set	20,01	1 set
103 345 032	350	320	set	22,13	1 set
103 345 033	400	390	set	24,25	1 set
103 345 034	450	450	set	27,28	1 set
103 345 035	500	500	set	29,56	1 set
103 345 036	550	550	set	30,62	1 set
103 345 037	600	600	set	32,89	1 set

Grupa produs 300 332

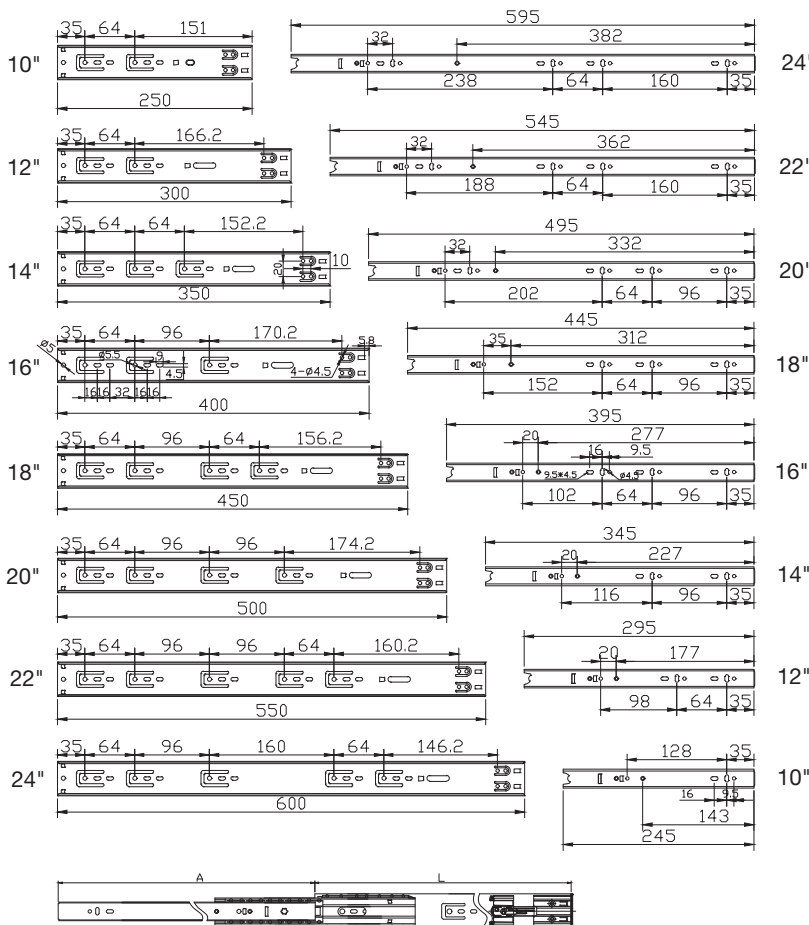

L	A
24"	600
22"	550
20"	500
18"	450
16"	390
14"	320
12"	240
10"	200





### Rulou standard

- Material de baza: placaj din fag
- Inaltime lamele 15 mm, element de capat 60 mm
- Partea din spate acoperita cu material textil (nuanta bej-marou)
- Suprafata bruta, slefuita si pregatita pentru lacuire

#### Nota:

Rulourile sunt disponibile numai in role intregi.

Lungime: 2400 mm  
 Grosime: 7,5 - 8 mm  
 Suprafata: brut



Art. nr.	Latime mm	Material	UM	Pret RON	per
103 352 746	600	fag	buc	2.291,20	1 buc
103 352 747	900	fag	buc	3.398,23	1 buc
103 352 744	600	stejar	buc	2.468,23	1 buc
103 352 745	900	stejar	buc	3.664,08	1 buc

Grupa produs 394

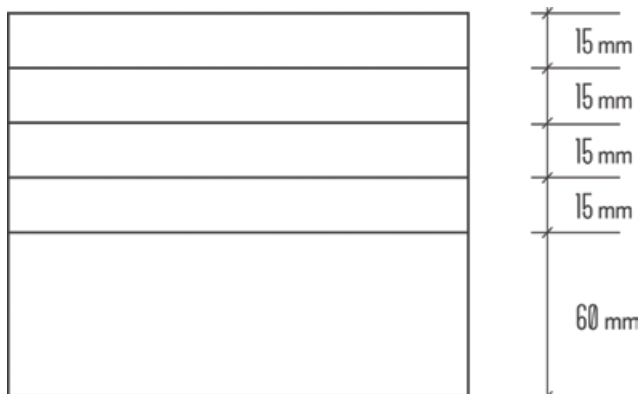

### Suport extractibil si rotativ pentru incaltaminte, set

Aduceti ordine si stil in holul de la intrare sau in dressing, cu acest **sistem extractibil pentru incaltaminte, rotativ la 360°**.

Aceasta piesa de mobilier, care economiseste spatiu, imbina functionalitatea cu un design modern si ofera o solutie eleganta pentru depozitarea incaltamintei.

- **Rotire la 360°:** rotire usoara pentru acces rapid la toata incaltamintea – ideal pentru spatii mici
- **Economisire de spatiu si design compact:** perfect pentru hol, dormitor sau dressinguri deschise
- **Capacitate mare:** mai multe niveluri ofera suficient spatiu pentru incaltaminte
- **Design modern:** aspect simplu si elegant, potrivit pentru orice stil de amenajare

#### Articolul include:

set feronerie  
cadru  
polite

Adancime montare min.: 380 mm

Latime montare min.: 764 mm

Art. nr.	Varianta	Inaltime de montare mm	Material	Culoare	UM	Pret RON	per
103 384 019	4 polite	790 - 990	otel	gri fier	set	885,59	1 set
103 384 020	10 polite	1630 - 1830	gri fier	set	1.310,28	1 set	

Grupa produs 300 F59

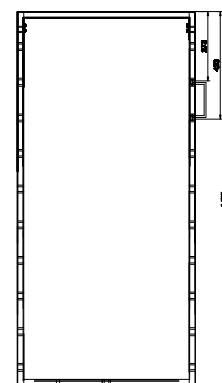
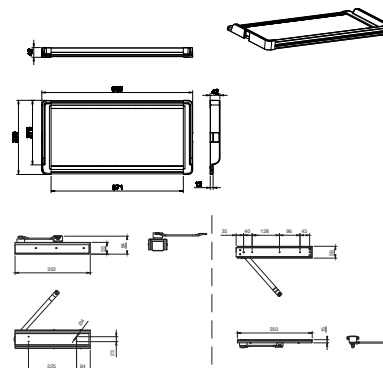
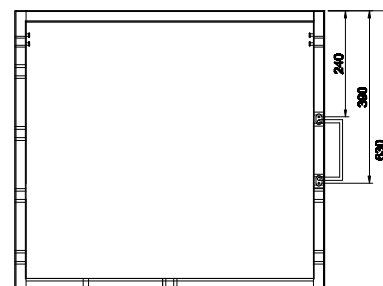



## Suport pentru tavi de cuptor VS ADD® Tray

### Articolul include:

1 buc. suporturi (stanga/dreapta)

Latime: 119 mm  
 Inaltime: 131 mm  
 Adancime: 410 mm  
 Tip montaj: fixare cu surub  
 Culoare: gri lava

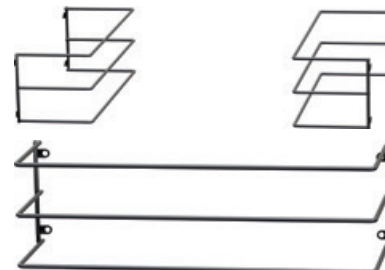

Art. nr.	Material	Suprafata	UM	Pret RON	per
103 384 052	otel	vopsit in camp electrostatic	set	172,18	1 set

Grupa produs 300 340





## FERONERIE PENTRU MOBILA

**L&S** Lighting Intelligence



### Corp de iluminat sub dulap Ucon 230 V

Corp de iluminat cu montaj sub dulap, cu utilizare versatila

- tehnologie LED durabila si economica din punct de vedere energetic
- ideala pentru iluminarea spatiilor de lucru
- sistem de cablare continua integrat pentru realizarea de benzi luminoase
- unghi de iluminare reglabil, rotire aprox. 90°

**Nota:**

Se pot realiza benzi luminoase cu o putere totala de pana la max. 100 W.  
Intrerupatorul PORNIT/OPRIT integrat actioneaza doar corpul de iluminat respectiv; alte corpuri de iluminat conectate nu sunt comutate.



**Articolul include:** cablu de alimentare, cablu de conectare si conector direct.

Dotare: corp de iluminat pivotant / intrerupator  
 Inaltime: 28 mm  
 Adancime: 78 mm  
 Temperatura de culoare lumina: 4000 K alb neutru  
 Material: aluminiu  
 Culoare: culoare aluminiu

Art. nr.	Lungime mm	Flux luminos (Lumen) lm	Putere W	Clasa eficienta energetica	UM	Pret RON	per
103 383 078 •	351	480	5	Acest produs contine o sursa de lumina cu clasa de eficienta energetica F	buc	170,66	1 buc
103 383 079 •	579	1070	10	Acest produs contine o sursa de lumina cu clasa de eficienta energetica F	buc	224,47	1 buc
103 383 080 •	911	1670	15	Acest produs contine o sursa de lumina cu clasa de eficienta energetica E	buc	302,98	1 buc
103 383 081 •	1212	2270	20	Acest produs contine o sursa de lumina cu clasa de eficienta energetica E	buc	331,32	1 buc

Grupa produs 300 361

