



Electromagneti Openers and Closers

Datorită dimensiunilor sale mici, acestia se pot monta în tocuri foarte înguste. Mulțumită spectrului larg de tensiune de 9 până la 24 V AC/DC, la care lucrează zăvorul electric, acest model se consideră un "talent multifuncțional".

- dimensiuni compacte
- se pot monta în lemn, PVC și aluminiu
- limbă reglabilă 2,1 mm
- la alegere cu deblocare și blocare mecanică



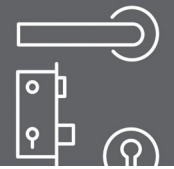

FERONERIE PENTRU CONSTRUCTII



Electromagnet usa 5U FGD, 9 - 24 V cu deblocare limba

- Limba reglabila 2,1 mm
- Adancime limba 5,2 mm
- Rezistenta la spargere 4800 N
- Test rezistenta 200.000 cicluri
- Tip montaj: orizontal sau vertical

Varianta cutie: simetric

Latime carcasa: 17,4 mm

Adancime carcasa: 28 mm

Tensiune: 9 - 24 V

Directie: universal

Art. nr.	Inaltime carcasa mm	Tip	Tip	Blocare	Raspuns	UM	Preț RON	per
102 275 907	65,5	5U0X21	Standard	nu	nu	buc	221,20	1 buc
102 275 911	72,9	5U6X21	Standard	nu	da	buc	324,03	1 buc
102 275 909	65,5	5U2X21	Standard	da	nu	buc	240,51	1 buc
102 275 908	65,5	5U1X21	deblocare mecanică	nu	nu	buc	227,72	1 buc
102 275 910	65,5	5U3X21	deblocare mecanică	da	nu	buc	247,03	1 buc

Grupă produs 200 C74



5U0X21 Standard



5U1X21 deblocare mecanica

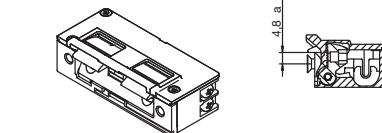
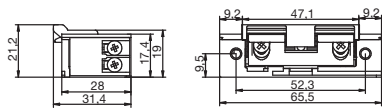

5U0X21 Standard

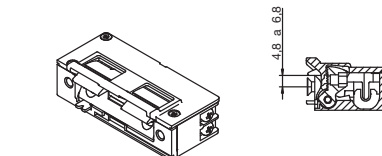
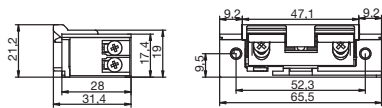

5U1X21 deblocare mecanica



5U6X21 Standard cu raspuns



5U3X21 blocare si deblocare mecanica



5U2X21 Standard cu blocare

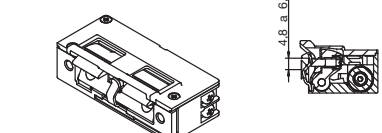
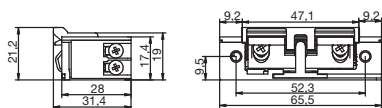

5U2X21 Standard cu blocare

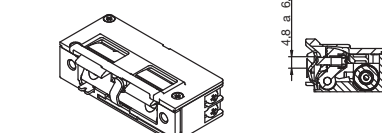
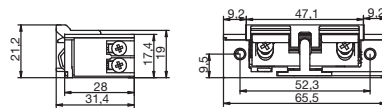

5U3X21 blocare si deblocare mecanica

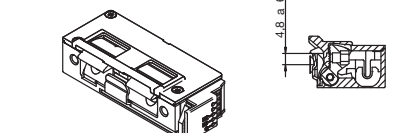
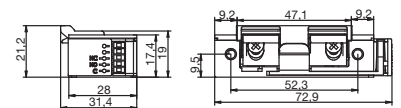

5U6X21 Standard cu raspuns



FERONERIE PENTRU CONSTRUCTII



Electromagnet cu deblocare limba FGD 5U4X21, 9-13V/DC fara contraplaca

- Limba reglabila 2,1 mm
- Adancime limba 5,2 mm
- Rezistenta la spargere 4800 N
- Test rezistenta 200.000 cicluri
- Tip montaj: orizontal sau vertical

Tip contact: contact de moment și continuu

Varianta cutie: simetric

Inaltime carcasa: 65,5 mm

Latime carcasa: 17,4 mm

Adancime carcasa: 28 mm

Tensiune: 9 - 13 V

Directie: universal

Tip: fara curent electric este deblocat

Blocare: nu

Art. nr.	Tip	Raspuns	UM	Preț RON	per
102 275 912	5U4X21	nu	buc	249,51	1 buc

Grupă produs 200 C74

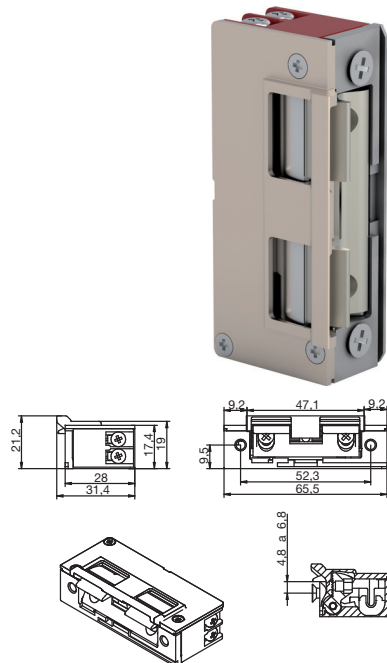

Electromagnet usa cu deblocare limba 5U FS FGD 9 - 13 V

- Limba reglabila 2,1 mm
- Adancime limba 6 mm
- Rezistenta la spargere 8000 N
- Test rezistenta 200.000 cicluri
- Tip montaj: orizontal sau vertical

Tip contact: contact de moment și durată

Varianta cutie: simetric

Latime carcasa: 17,4 mm

Adancime carcasa: 28 mm

Tensiune: 9 - 13 V

Directie: universal

Tip: Standard

Blocare: nu

Art. nr.	Inaltime carcasa mm	Tip	Raspuns	UM	Preț RON	per
102 275 913	65.5	5UF0X21	nu	buc	1.224,99	1 buc
102 275 914	72.9	5UF6X21	da	buc	1.426,48	1 buc

Grupă produs 200 C74



5UF6X21 Standard cu raspuns 5UF0X21 Standard

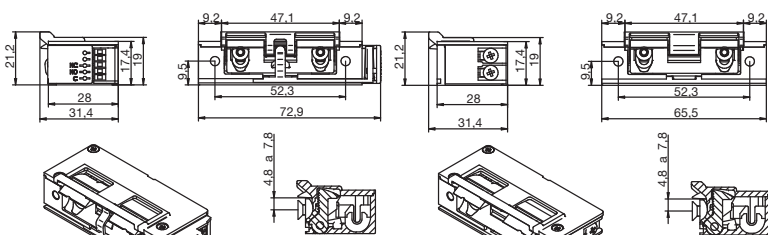

5UF6X21 Standard cu raspuns

5UF0X21 Standard



FERONERIE PENTRU CONSTRUCTII



Electromagnet cu deblocare limba FGD 5E FS, 6-28V/DC electronica preincarcare

- Preincarcare AC: 400 N, DC
- Limba reglabila 2,1 mm
- Adancime limba 6 mm
- Rezistenta la spargere 8000 N
- Test rezistenta 200.000 cicluri
- Tip montaj: orizontal sau vertical

Notă: Adecvat pentru utilizare la ușile cu protecție împotriva incendiilor (este necesară aprobarea producătorului de usa si toc) . Alimentarea continuă este permisă numai dacă sunt respectate reglementările de construcție (de exemplu, legătura cu sistemul de alarmă la incendiu).

Tip contact: contact de moment și continuu
 Variantă cutie: simetric
 Latime carcasa: 17,4 mm
 Adâncime carcasă: 28 mm
 Tensiune: 6 - 28 V
 Direcție: universal
 Blocare: nu



5EF6Z21 Standard cu electronica presarcina, cu raspuns
 5EF0Z21 Standard cu electronica presarcina

Art. nr.	Inaltime carcasa mm	Tip	Tip	Raspuns	UM	Preț RON	per
102 275 915	72.9	5EF0Z21	Standard cu electronica presarcina, fara contraplaca	nu	buc	1.529,84	1 buc
102 275 916	80.3	5EF6Z21	Standard cu electronica presarcina	da	buc	1.802,06	1 buc

Grupă produs 200 C74

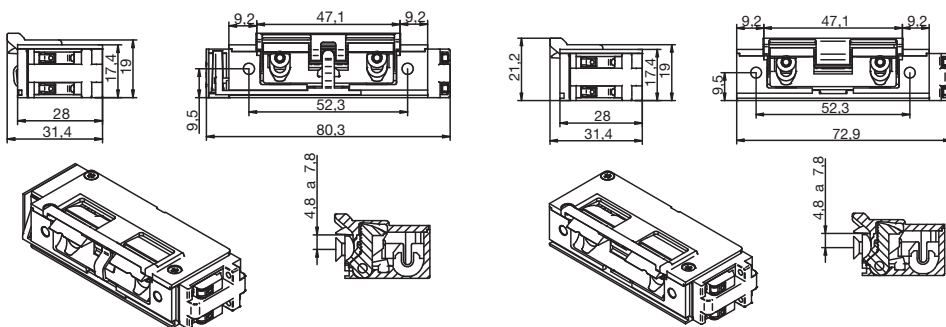

5EF6Z21 Standard cu electronica presarcina, cu raspuns

5EF0Z21 Standard cu electronica presarcina



FERONERIE PENTRU CONSTRUCTII



Contraplaca pentru electromagnet FGD cu deblocare limba

Tip montaj: electromagnet usa FGD

Grosime material: 3 mm

Directie: universal

Material: inox

Art. nr.	Cod producător	Tip	Înălțime aripi mm	Lățime aripi mm	UM	Preț RON	per
102 275 934	L96XD	rotund, lung	250	34	buc	83,78	1 buc
102 275 931	S96XD	rotund, scurt	172	34	buc	69,69	1 buc
102 275 932	L94XD	unghiular, lung	250	28	buc	79,08	1 buc
102 275 933	L95XD	unghiular, lung	250	34	buc	83,78	1 buc
102 275 929	S94XD	unghiular, scurt	110	28	buc	61,33	1 buc
102 275 930	S95XD	unghiular, scurt	172	34	buc	69,69	1 buc

Grupă produs 200 C74

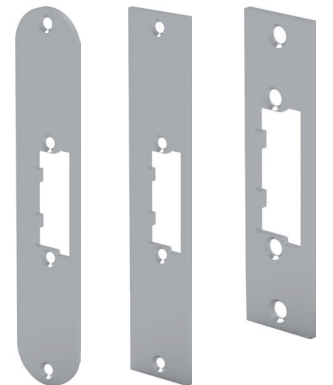

S96XD rotund, scurt

S95XD unghiular, scurt

S94XD unghiular, scurt

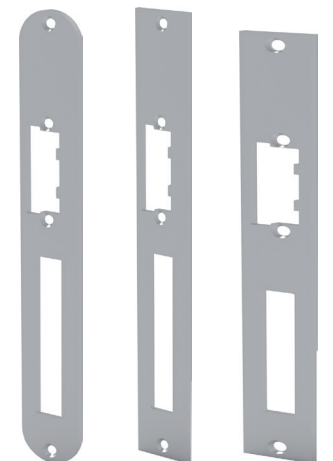

L96XD rotund, lung

L95XD unghiular, lung

L94XD unghiular, lung

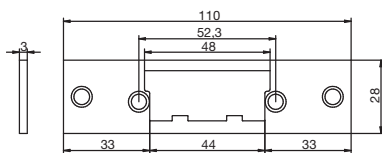

S94XD unghiular, scurt

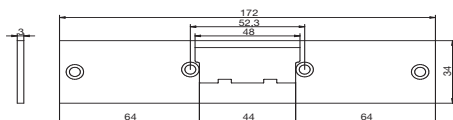

S95XD unghiular, scurt

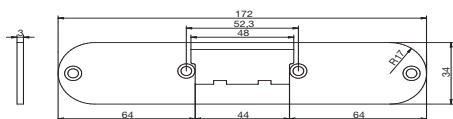

S96XD rotund, scurt

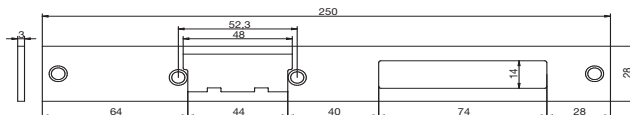

L94XD unghiular, lung

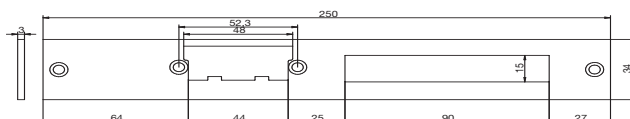

L95XD unghiular, lung

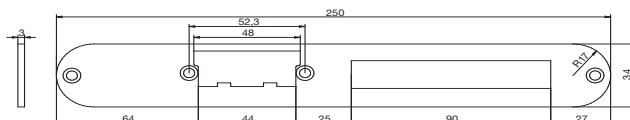

L96XD rotund, lung

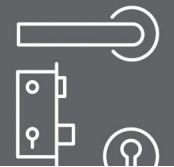

FERONERIE PENTRU CONSTRUCTII



Contact trecere curenti slabi 2 pini DDC1W

Contactele electrice de trecere O&C sunt concepute special pentru a alimenta in mod discret si eficient dispozitivele electronice de blocare/deblocare din cadrul usii dvs, fara cabluri vizibile, contactele mici sunt incorporate in tocul usii si in usa pe partea cu balamale, astfel incat dupa inchiderea usii contactele sa ramana complet invizibile.

Înălțime aripi: 79 mm
Lățime aripi: 13 mm
Grosime material: 5 mm

Art. nr.	Cod producător	Material	UM	Preț RON	per
102 275 996	DDC1W	plastic	buc	45,54	1 buc

Grupă produs 200 C74

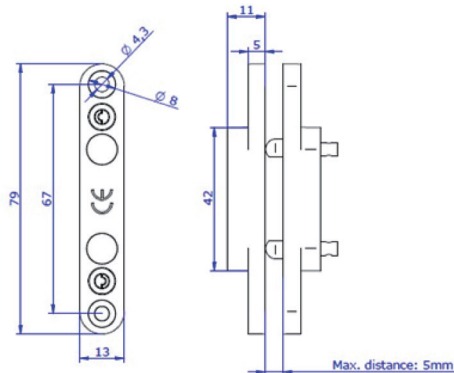

Contact trecere curenti slabi 3 pini DDC3W

Contactele electrice de trecere O&C sunt concepute special pentru a alimenta in mod discret si eficient dispozitivele electronice de blocare/deblocare din cadrul usii dvs, fara cabluri vizibile, contactele mici sunt incorporate in tocul usii si in usa pe partea cu balamale, astfel incat dupa inchiderea usii contactele sa ramana complet invizibile.

Înălțime aripi: 86 mm
Lățime aripi: 20 mm
Grosime material: 4,8 mm

Art. nr.	Cod producător	Material	UM	Preț RON	per
102 275 997	DDC3W	plastic	buc	172,52	1 buc

Grupă produs 200 C74

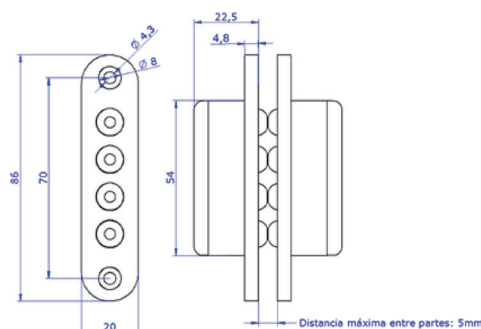



FERONERIE PENTRU CONSTRUCTII



Contact trecere curenti slabi 4 pini DDC4W

Contactele electrice de trecere O&C sunt concepute special pentru a alimenta in mod discret si eficient dispozitivele electronice de blocare/deblocare din cadrul usii dvs, fara cabluri vizibile, contactele mici sunt incorporate in tocul usii si in usa pe partea cu balamale, astfel incat dupa inchiderea usii contactele sa ramana complet invizibile.

Înălțime aripi: 86 mm
Lățime aripi: 20 mm
Grosime material: 4,8 mm

Art. nr.	Cod producător	Material	UM	Preț RON	per
102 275 998 •	DDC4W	plastic	buc	208,02	1 buc

Grupă produs 200 C74

