



## Usi pliante si culisante Hettich WingLine L

- Mecanism de deschidere nou Push/Pull to Move - o miscare a mainii si intregul continut al dulapului este accesibil
- Amortizare de deschidere si inchidere
- Usi cu inaltime de 2400 mm, greutate de pana la 25 kg





### Sistem usi pliante WingLine L 12

- Setul de culisare contine toate piesele necesare pentru 1 usa pliabila glisanta cu 2 canate
- Setul de culisare poate fi utilizat la o aplicatie standard pentru usi pliabile fara mecanism de deschidere
- Setul de culisare poate fi utilizat în combinatie cu Pull to move Silent
- Piese de culisare cu sau fara sistem de inchidere automată cu arc
- Piesa de culisare cu functie de asamblare rapida

Capacitate portantă: 12 kg  
 Înălțime canat până la: 2400 mm  
 Lățime canat de la: 250 mm  
 Tip montaj: fronturi lemn

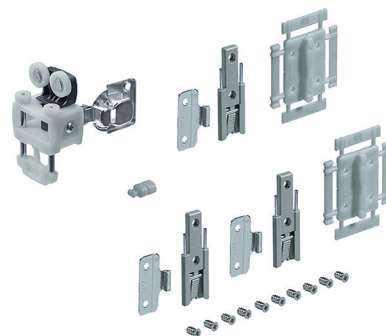

Art. nr.	Varianta	Varianta 2	Direcție	UM	Preț RON	per
103 313 383	cu arc	cu ghidaj inferior	stanga	set	34.739,24	100 seturi
103 313 384	cu arc	cu ghidaj inferior	dreapta	set	34.739,24	100 seturi
103 313 385	fara arc	cu ghidaj inferior	stanga	set	34.881,91	100 seturi
103 313 386	fara arc	cu ghidaj inferior	dreapta	set	34.881,91	100 seturi
103 313 387	cu arc	fara ghidaj inferior	stanga	set	22.960,08	100 seturi
103 313 388	cu arc	fara ghidaj inferior	dreapta	set	22.960,08	100 seturi
103 313 389	fara arc	fara ghidaj inferior	stanga	set	22.960,08	100 seturi
103 313 390	fara arc	fara ghidaj inferior	dreapta	set	22.960,08	100 seturi

Grupă produs 313 F16

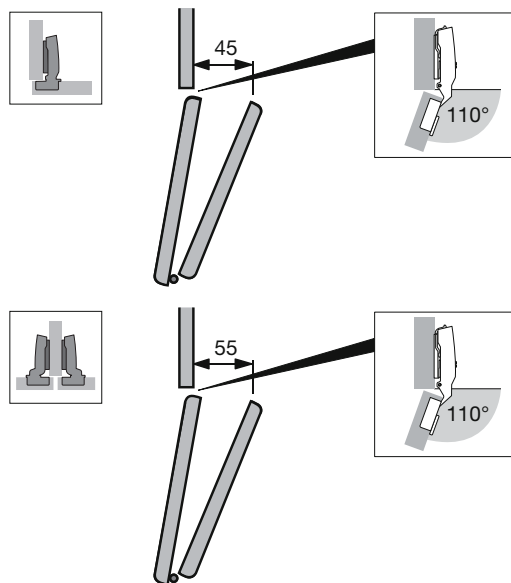
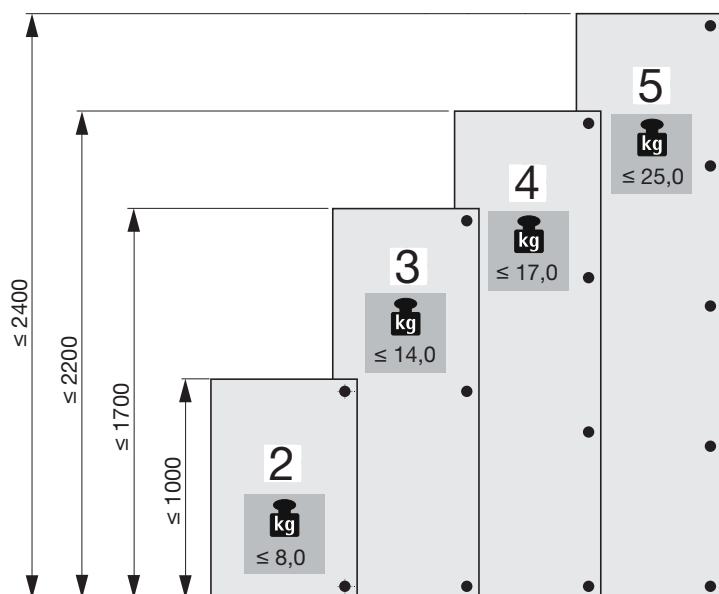



### Sistem usi pliante WingLine L 12

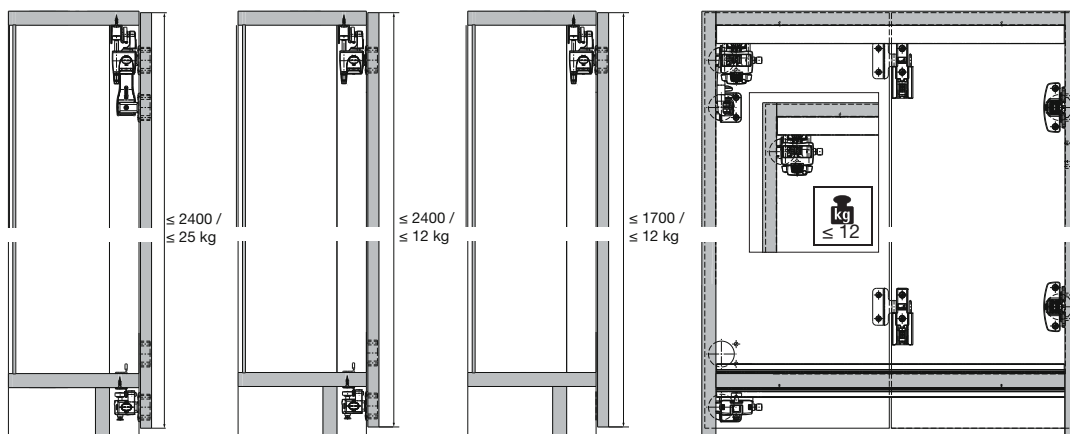
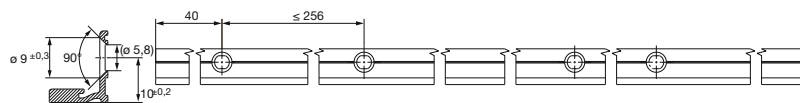
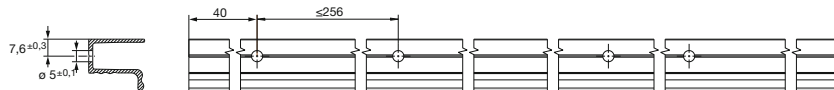
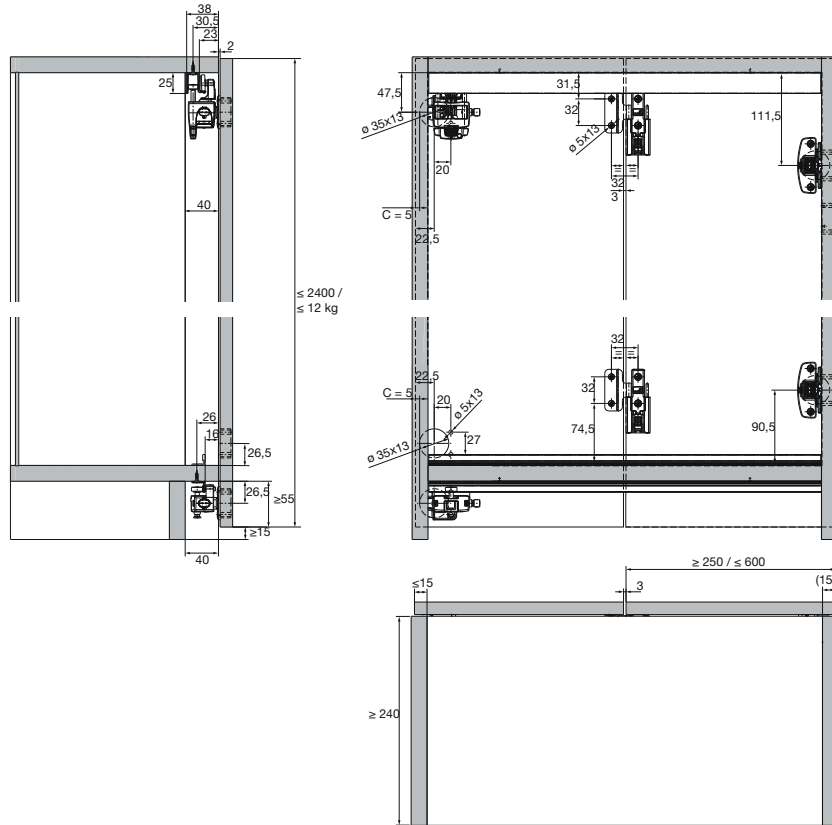



### Sistem usi pliante WingLine L 25

- Setul de culisare contine toate piesele necesare pentru 1 usa pliabila glisanta cu 2 canate
- Setul de culisare poate fi utilizat la o aplicatie standard pentru usi pliabile fara mecanism de deschidere
- Setul de culisare poate fi utilizat în combinatie cu Pull to move Silent
- Piese de culisare cu sau fara sistem de inchidere automată cu arc
- Piesa de culisare cu functie de asamblare rapida

Capacitate portantă: 25 kg  
 Înălțime canat până la: 2400 mm  
 Lățime cercvea de la: 250 mm

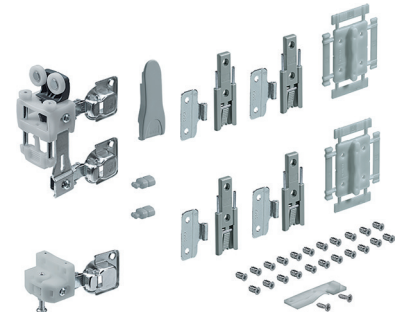

Art. nr.	Varianta	Tip montaj	Direcție	UM	Preț RON	per
103 313 379	cu arc	fronturi lemn	stanga	set	38.353,59	100 seturi
103 313 380	cu arc	fronturi lemn	dreapta	set	38.353,59	100 seturi
103 313 381	fara arc	fronturi lemn	stanga	set	19.809,86	100 seturi
103 313 382	fara arc	fronturi lemn	dreapta	set	19.809,86	100 seturi

Grupă produs 313 F16

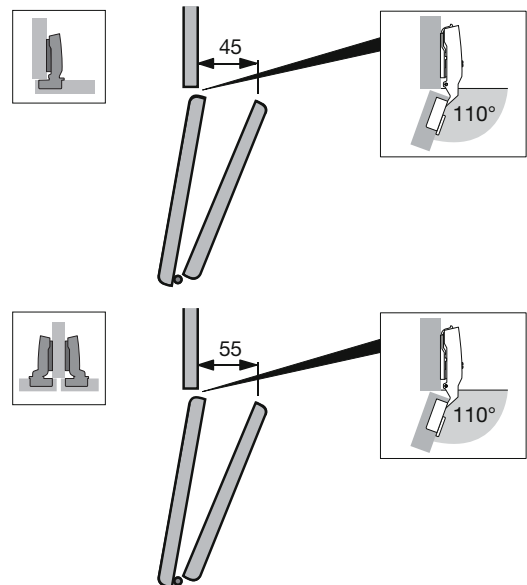
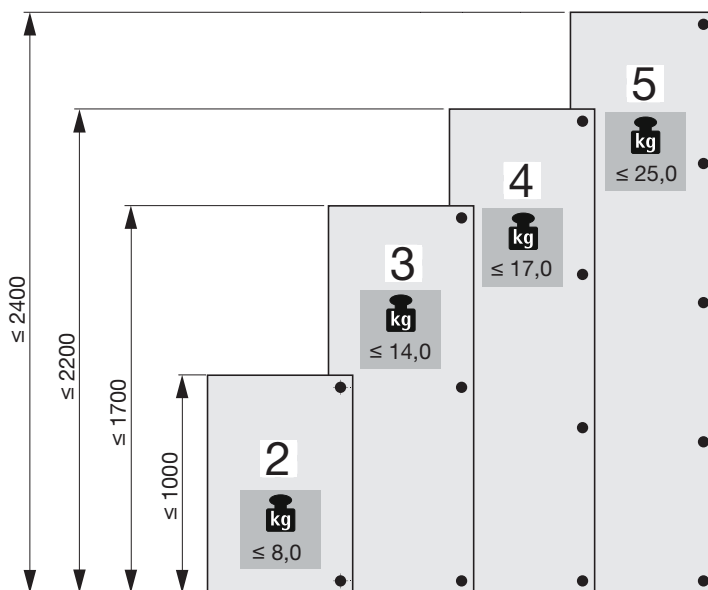



### Sistem usi pliante WingLine L 25

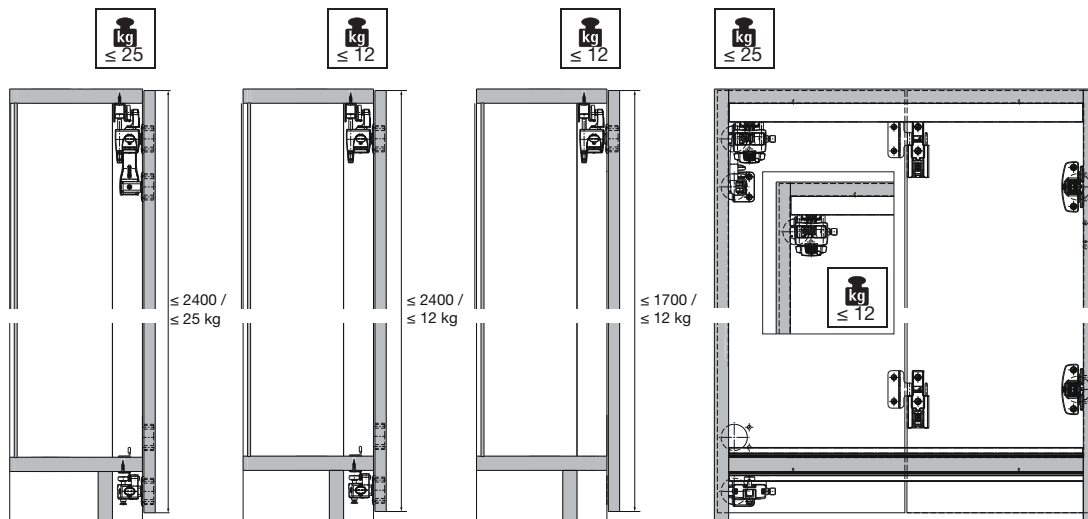
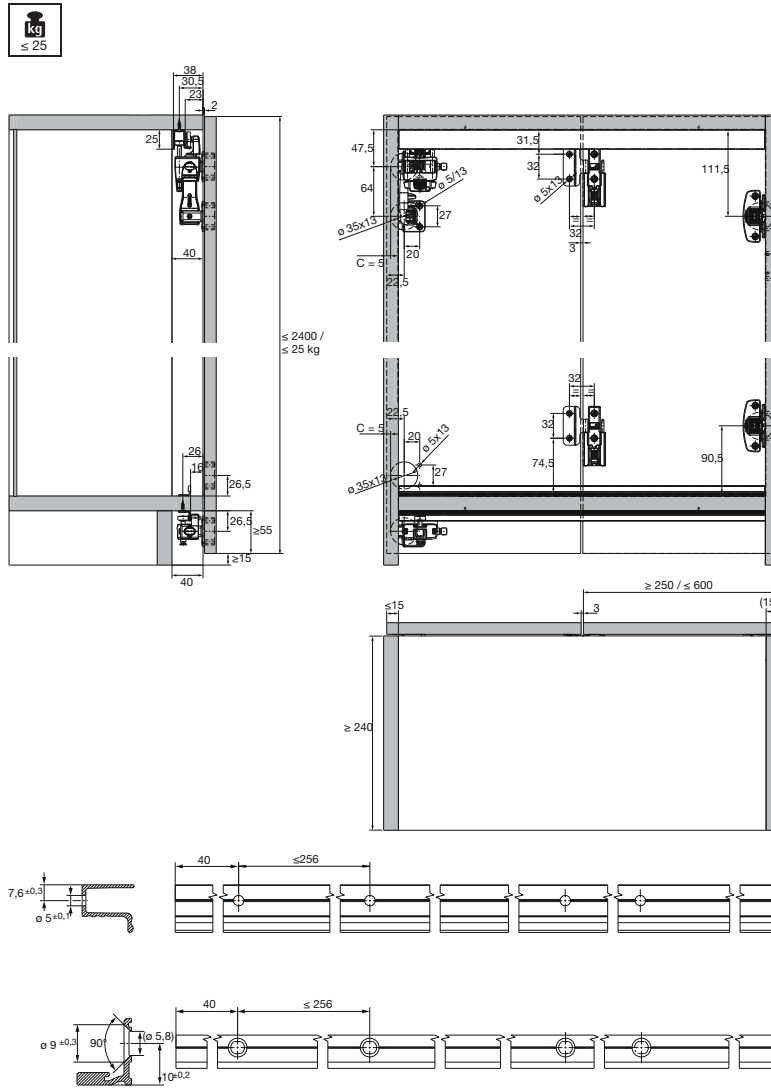



### Profil ghidare HETTICH WingLine L

Varianta: perforat pentru insurubare  
 Lungime: 2400 mm  
 Material: aluminiu  
 Finisaj: eloxat

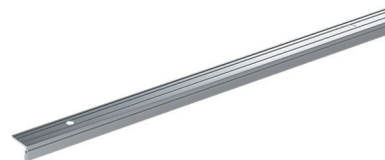

Art. nr.	UM	Preț RON	per
103 313 377	buc	17.406,19	100 buc

Grupă produs YH1 YH9



### Profil culisare HETTICH WingLine L

Varianta: perforat pentru insurubare  
 Lungime: 2400 mm  
 Material: aluminiu  
 Finisaj: eloxat

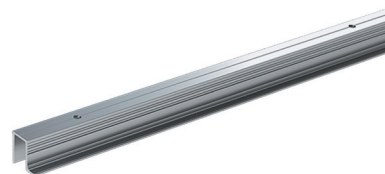

Art. nr.	UM	Preț RON	per
103 313 376	buc	25.195,41	100 buc

Grupă produs YH1 YH9



### Clema montaj profil HETTICH WingLine L

- Menținerea sigură a profilelor în poziția corectă de insurubare
- Clema de montaj se poate utiliza la profilul de culisare și la cel de ghidare (deasupra și sub soclu)

Sistem: profil de ghidare și culisare  
 Material: plastic

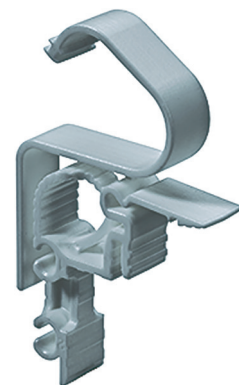

Art. nr.	UM	Preț RON	per
103 313 378	set	1.018,23	100 seturi

Grupă produs YH1 YH9



### Set profile glisare WingLine L 2400

Capacitate portantă: 25 kg kg  
 Tip ușă: glisanta  
 Tip montaj: cu suruburi

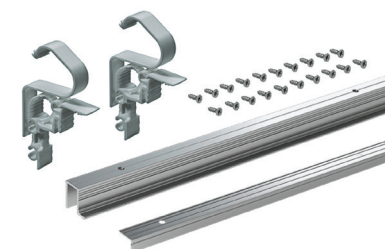

Art. nr.	UM	Preț RON	per
103 313 409	set	25.786,33	100 seturi

Grupă produs 313 F16



### Piesa mentinere usa deschisa HETTICH WingLine

- mentine usile sigur, in pozitie deschisa
- impiedica arcurile sa retraga usile
- pentru fiecare set de usi se monteaza un mecanism de mentinere deschisa
- nu este necesar la utilizarea de Push to move, Pull to move sau Pull to move Silent

Material: plastic  
Finisaj: gri

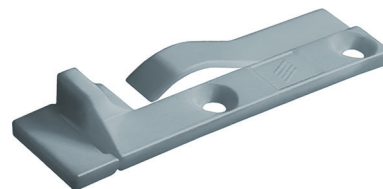

Art. nr.	Direcție	UM	Preț RON	per
103 313 410	stanga	set	574,39	100 seturi
103 313 411	dreapta	set	574,39	100 seturi

Grupă produs YH1 YH9



### Mecanism deschidere HETTICH WingLine L Pull to move Silent

- Mecanism pentru deschiderea automata a unei uși, cu efort minim
- Setul conține toate componentele necesare pentru deschiderea unei uși glisante pliante cu 2 canate.

#### Articolul include:

- 1 buc unitate Pull to move Silent
- 1 buc cuplaj de fixare pe usa
- 1 buc sablon
- suruburi fixare

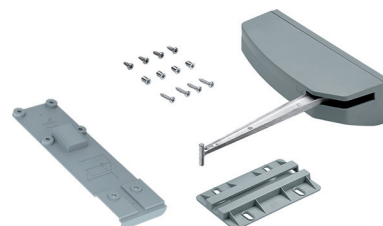

Pull to move Silent

Art. nr.	Varianta	Direcție	UM	Preț RON	per
103 313 403	usi de greutate mica	stanga	set	50.704,80	100 seturi
103 313 404	usi de greutate mica	dreapta	set	50.704,80	100 seturi
103 313 405	usi de greutate medie	stanga	set	50.704,80	100 seturi
103 313 406	usi de greutate medie	dreapta	set	50.704,80	100 seturi
103 313 407	usi de greutate mare	stanga	set	50.704,80	100 seturi
103 313 408	usi de greutate medie	dreapta	set	50.704,80	100 seturi

Grupă produs 313 F16

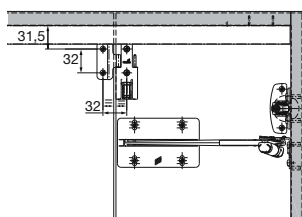
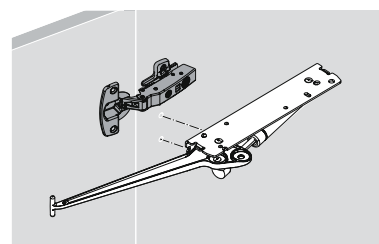

Pull to move Silent

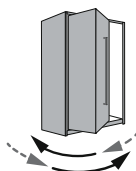



### Mecanism deschidere HETTICH WingLine L Pull to move

- Mecanism pentru deschiderea automata a unei uși, cu efort minim
- Setul conține toate componentele necesare pentru deschiderea unei uși glisante pliante cu 2 canate.

#### Articolul include:

- 1 buc unitate Pull to move
- 1 buc suport cu 2 magneti
- 2 buc contraplaci magnetice
- 1 buc cuplaj de fixare pe usa
- 1 buc sablon
- suruburi fixare

Tip: WingLine L Pull to move

Art. nr.	Varianta	Direcție	UM	Preț RON	per
103 313 397	usi de greutate mica	stanga	set	58.505,42	100 seturi
103 313 398	usi de greutate mica	dreapta	set	58.505,42	100 seturi
103 313 399	usi de greutate medie	stanga	set	58.505,42	100 seturi
103 313 400	usi de greutate medie	dreapta	set	58.505,42	100 seturi
103 313 401	usi de greutate mare	stanga	set	58.505,42	100 seturi
103 313 402	usi de greutate mare	dreapta	set	58.505,42	100 seturi

Grupă produs 313 F16

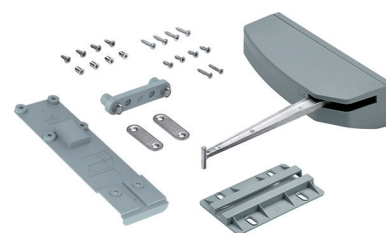

Pull to move

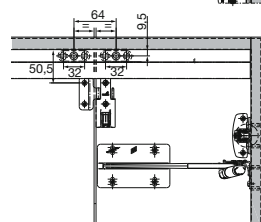
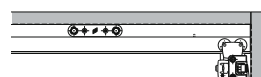
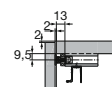
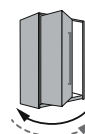

### Mecanism WingLine L Push deschidere automata

Art. nr.	Varianta	Direcție	UM	Preț RON	per
103 313 391	usi de greutate mica	stanga	set	58.505,42	100 seturi
103 313 392	usi de greutate mica	dreapta	set	58.505,42	100 seturi
103 313 393	usi de greutate medie	stanga	set	58.505,42	100 seturi
103 313 394	usi de greutate medie	dreapta	set	58.505,42	100 seturi
103 313 395	usi de greutate mare	stanga	set	30.218,38	100 seturi
103 313 396	usi de greutate mare	dreapta	set	30.218,38	100 seturi

Grupă produs 313 F16

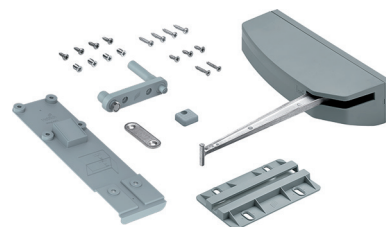

Push to move

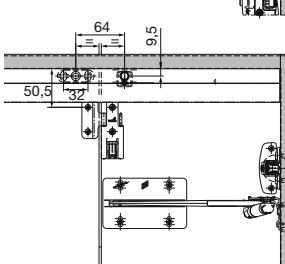
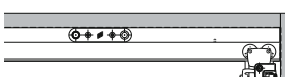
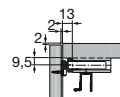

Push to move

